

Tooling for crimp technology

Page

General information **31.02**

Specific tooling

D-Sub – S **31.04**

D-Sub – HD **31.04**

D-Sub – M **31.08**

D-Sub – InduCom **31.11**

Crimp connection

A perfect crimp connection is gastight and therefore corrosion free. It is equivalent to a cold weld of the connected parts. For this reason, major features in achieving high quality crimp connections are the design of the crimping areas of the contact and of course the crimping tool itself. Wires to be connected must be carefully matched to the correct size of crimp contacts. If these basic requirements are met, users will be assured of highly reliable connections with a low contact resistance and a high resistance against corrosion.

The economical and technical advantages are:

- Constant contact resistance as a result of an unvariable crimp connection quality
- Corrosion free connections as a result of cold weld action
- Preparation of harnessing with crimp contacts already fitted
- More economic cable connection

Requirements for crimp connections are set out in DIN EN 60352-2.

Pull out force of stranded wire

An essential consideration for a good quality of crimp connection is the mechanical retention of the wire in the crimp contact. As set out in DIN EN 60352-2 the pull out force of the wire from the crimp must be at least 60 % (at 0.75 mm²) of the breaking force of the wire itself.

The adjacent diagram shows tensile strength plotted against wire cross sectional area. From this you can see the relationship between the breaking strength of wires and the force necessary to destroy HARTING crimp connections.

- ① Tensile strength of stranded wire
- ② Pull out force of wires from HARTING crimp contacts



B shape cross section stamped contact

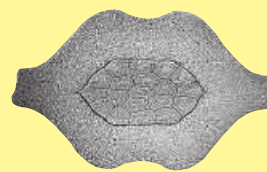

H shape cross section turned contact

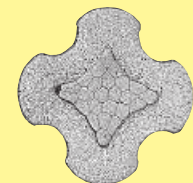

4 points shape cross section turned contact

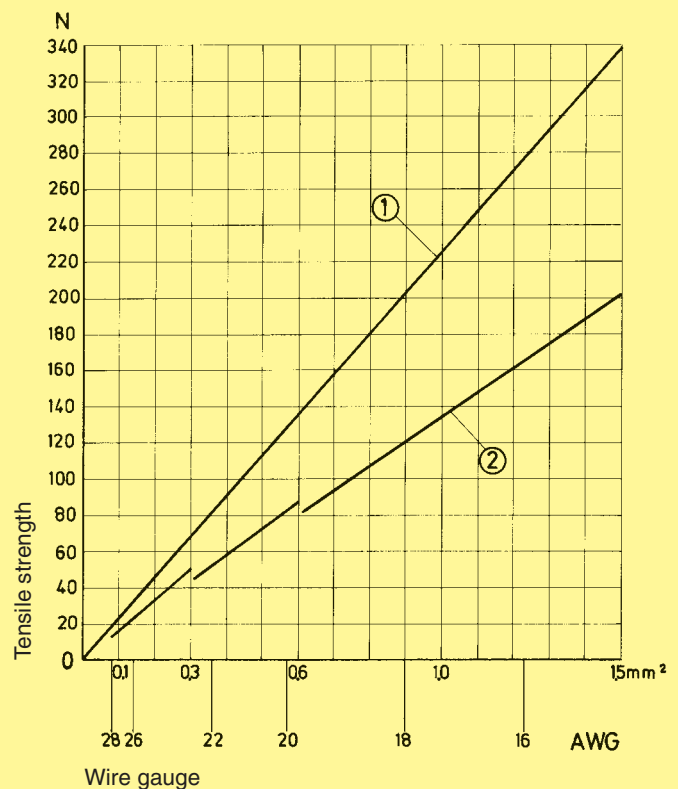

Crimping tools

Crimping tools (hand operated or automatic) are carefully designed to guarantee a symmetrical deformation of the crimping area of the contact and the wire through the high pressure forming parts of the tool. The locator automatically engages the crimp contact and the wire at the correct point in the tool. The wire insulation can also be included as a secondary feature of some crimp contacts to care for additional mechanical strength.

The ratchet in the tool performs 2 functions:

- ① It prevents insertion of the crimp into the tool for crimping before the jaws are fully open
- ② It prevents the tool from being opened before the crimping action is completed

A quality crimp connection can be achieved with this crimping system.

The adjacent sketches show important features of the HARTING hand crimping tool.

The HARTING automatic crimping tool uses bandoliered contacts.

The machine strips insulation from the wire and then crimps the contact. Both the crimping area and the insulation support are independently adjustable to facilitate the use of any wire type with dimensions within the stated crimp capacity.

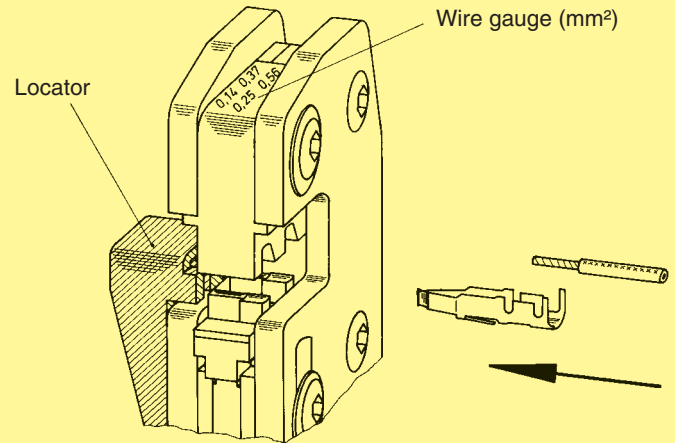

Tools for crimp termination

Identification	Part No.	
Service crimp tool for single standard contacts for single high density contacts	09 99 000 0175 09 99 000 0596	
HARTING-Crimp tool for 500 bandoliered standard contacts for 500 bandoliered high density contacts	09 99 000 0169 09 99 000 0597	
HARTING-Semi-automatic crimping device Main drive foot-operated 220 V / 50 Hz Crimping head for bandoliered standard contacts Reel holder for 10 000 contacts	09 99 000 0246 09 99 000 0253 09 99 000 0158	Wire gauge 0.09-0.56 mm ² (AWG 28-20)
Insertion and removal tool for single standard contacts for single high density contacts	09 99 000 0171 09 99 000 0513	 <p>Assembly of crimp contacts After crimping the stranded wire to the contact using a hand tool or automatic crimping device, insert the contact into the chamber with the tool, working from the wiring side. You will hear the contacts snap home and to check that they are securely in place, give the wire a gentle pull.</p> <p>Removing crimp contacts Position the tool from the wiring side as shown in the diagram below and insert into the contact chamber. The contact can then easily be removed from the wiring side together with the wire itself and reinserted in a different chamber. The tool is designed for a maximum insulation diameter of Ø 1.7 mm.</p>

Tooling crimp

Stripping length: 2.5 + 0.5 mm

For all crimp tools: These tools are designed specifically for standard wires and not for solid wires.

Tools for crimp termination

Identification	Part No.	Drawing																											
<p>Crimp tool for turned male and female contacts AWG 28-18 8 indent crimp in acc. to MIL 22 520/2-01</p>	<p>09 99 000 0501</p>	 <table border="1" data-bbox="775 663 1495 1093"> <thead> <tr> <th>Part No. contact</th> <th>Part No. locator</th> <th>Crimp tool selection no.</th> </tr> </thead> <tbody> <tr><td>61 03 000 0112</td><td>61 03 600 0024</td><td>7</td></tr> <tr><td>61 03 000 0113</td><td>61 03 600 0024</td><td>7</td></tr> <tr><td>61 03 000 0073</td><td>61 03 600 0023</td><td>7</td></tr> <tr><td>61 03 000 0074</td><td>61 03 600 0023</td><td>7</td></tr> <tr><td>61 03 000 0094</td><td>61 03 600 0023</td><td>7</td></tr> <tr><td>61 03 000 0096</td><td>61 03 600 0023</td><td>7</td></tr> <tr><td>61 03 000 0078</td><td>61 03 600 0023</td><td>7</td></tr> <tr><td>61 03 000 0080</td><td>61 03 600 0023</td><td>7</td></tr> </tbody> </table>	Part No. contact	Part No. locator	Crimp tool selection no.	61 03 000 0112	61 03 600 0024	7	61 03 000 0113	61 03 600 0024	7	61 03 000 0073	61 03 600 0023	7	61 03 000 0074	61 03 600 0023	7	61 03 000 0094	61 03 600 0023	7	61 03 000 0096	61 03 600 0023	7	61 03 000 0078	61 03 600 0023	7	61 03 000 0080	61 03 600 0023	7
Part No. contact	Part No. locator	Crimp tool selection no.																											
61 03 000 0112	61 03 600 0024	7																											
61 03 000 0113	61 03 600 0024	7																											
61 03 000 0073	61 03 600 0023	7																											
61 03 000 0074	61 03 600 0023	7																											
61 03 000 0094	61 03 600 0023	7																											
61 03 000 0096	61 03 600 0023	7																											
61 03 000 0078	61 03 600 0023	7																											
61 03 000 0080	61 03 600 0023	7																											
<p>Locator for crimp tool Details see table</p>	<p>61 03 600 0023 61 03 600 0024</p>																												

Automated crimping machine type BK

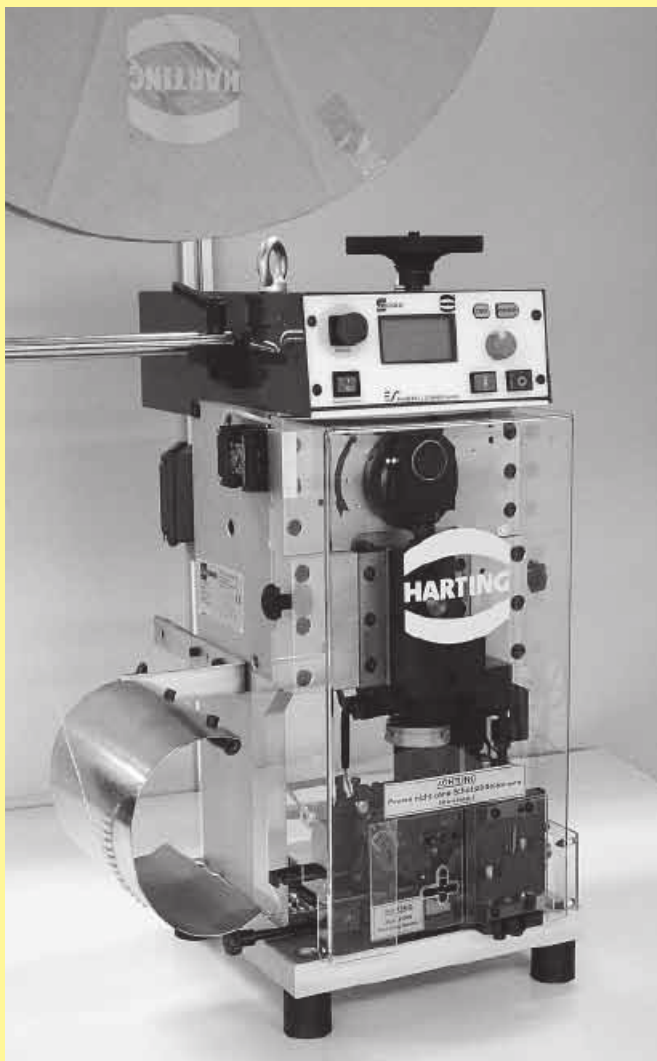

Main characteristics

- Smooth run through electronic brakes
- Hand wheel for manual adjustments
- Maintenance friendly through needle bearing rail
- Simple handling by quick change tool and stripper

Part No. 09 98 000 5000

Technical characteristics

Dimensions

Height	690 mm (1400 mm with a contact reel)
Width	350 mm
Depth	370 mm

Total weight 72 kg

Power supply 230 V, 50/60 Hz, 2.5 A

Consumption 0.75 kW

Motor speed 440 - 2000 rpm

Cable length 2 m incl. plug

Control SPS

Work cycle trigger Sensor

Work cycle 0.35 s for stripping and crimping

Illumination Integrated tool light

Stroke counter Daywise and fixed

Crimp force monitor BB07i

Crimping tool Quick change tool

Adjustable process parameters
 Crimping height on wire
 Crimping height on insulation
 Depth of insulation stripping
 Length of insulation stripping
 Wire retainer position
 Wire position in the crimp contact
 Band thrust

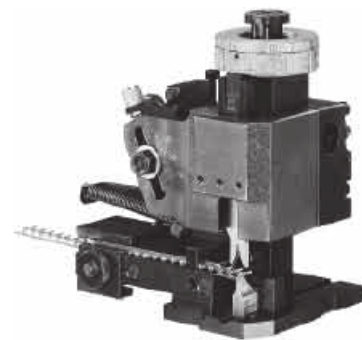





Identification	for use with	Part No.	Wire gauge [mm ²]	AWG	Insulation [Ø mm]	
Crimping tool for DIN 41 612 connectors ¹⁾	contacts BC	09 98 000 3004	0.09 - 0.56	28 - 20	0.7 - 1.6	
	contacts FC 1	09 98 000 3005	0.09 - 0.25	28 - 24	0.7 - 1.6	
	FC 2	09 98 000 3006	0.14 - 0.56	26 - 20	0.8 - 2.3	
	FC 3	09 98 000 3007	0.50 - 1.50	20 - 16	1.6 - 2.8	
	for D-Sub connectors ²⁾	standard contacts	09 98 000 3008 09 98 000 3009	0.09 - 0.25 0.25 - 0.56	28 - 24 24 - 20	0.7 - 1.4 0.9 - 1.7
		high density contacts	09 98 000 3012		26 - 24	0.8 - 1.4

¹⁾ 3.5 + 0.5 mm of insulation is stripped from the wire to be crimped

²⁾ 2.5 + 0.5 mm of insulation is stripped from the wire to be crimped

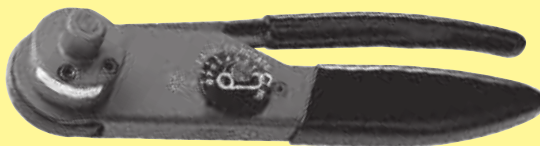



Tools for crimp termination

Identification	Part No.																												
Hand crimp tool for signal contacts	09 99 000 0501	 Wire gauge AWG 18 – 28																											
Die (To be ordered separately.)	09 99 000 0502																												
Hand crimp tool with fixed die for signal contacts	09 99 000 0505	 Wire gauge AWG 20 – 26																											
Hand crimp tool for power contacts	09 99 000 0509																												
Positioner for male and female contacts (To be ordered separately.)	09 99 000 0504	<table border="1"> <thead> <tr> <th>Contact Part No.</th> <th>Gauge</th> <th>Tool setting</th> </tr> </thead> <tbody> <tr> <td>09 69 182 5420</td> <td>AWG 16, 18, 20</td> <td>3 for AWG 16, 2 for AWG 18 and AWG 20</td> </tr> <tr> <td>09 69 282 5420</td> <td>AWG 16, 18, 20</td> <td>3 for AWG 16, 2 for AWG 18 and AWG 20</td> </tr> <tr> <td>09 69 182 5421</td> <td>AWG 12, 14</td> <td>5 for AWG 12 and 4 for AWG 14</td> </tr> <tr> <td>09 69 282 5421</td> <td>AWG 12, 14</td> <td>5 for AWG 12 and 4 for AWG 14</td> </tr> <tr> <td>09 69 182 5422</td> <td>AWG 10, 12</td> <td>7 for AWG 10 and 6 for AWG 12</td> </tr> <tr> <td>09 69 282 5422</td> <td>AWG 10, 12</td> <td>7 for AWG 10 and 6 for AWG 12</td> </tr> <tr> <td>09 69 182 5423</td> <td>AWG 8, 10</td> <td>7 for AWG 8 and 6 for AWG 10</td> </tr> <tr> <td>09 69 282 5423</td> <td>AWG 8, 10</td> <td>7 for AWG 8 and 6 for AWG 10</td> </tr> </tbody> </table>	Contact Part No.	Gauge	Tool setting	09 69 182 5420	AWG 16, 18, 20	3 for AWG 16, 2 for AWG 18 and AWG 20	09 69 282 5420	AWG 16, 18, 20	3 for AWG 16, 2 for AWG 18 and AWG 20	09 69 182 5421	AWG 12, 14	5 for AWG 12 and 4 for AWG 14	09 69 282 5421	AWG 12, 14	5 for AWG 12 and 4 for AWG 14	09 69 182 5422	AWG 10, 12	7 for AWG 10 and 6 for AWG 12	09 69 282 5422	AWG 10, 12	7 for AWG 10 and 6 for AWG 12	09 69 182 5423	AWG 8, 10	7 for AWG 8 and 6 for AWG 10	09 69 282 5423	AWG 8, 10	7 for AWG 8 and 6 for AWG 10
Contact Part No.	Gauge	Tool setting																											
09 69 182 5420	AWG 16, 18, 20	3 for AWG 16, 2 for AWG 18 and AWG 20																											
09 69 282 5420	AWG 16, 18, 20	3 for AWG 16, 2 for AWG 18 and AWG 20																											
09 69 182 5421	AWG 12, 14	5 for AWG 12 and 4 for AWG 14																											
09 69 282 5421	AWG 12, 14	5 for AWG 12 and 4 for AWG 14																											
09 69 182 5422	AWG 10, 12	7 for AWG 10 and 6 for AWG 12																											
09 69 282 5422	AWG 10, 12	7 for AWG 10 and 6 for AWG 12																											
09 69 182 5423	AWG 8, 10	7 for AWG 8 and 6 for AWG 10																											
09 69 282 5423	AWG 8, 10	7 for AWG 8 and 6 for AWG 10																											
Hand crimp tool for coaxial contacts, solder/crimp version ¹⁾	09 99 000 0503																												
Die (To be ordered separately.)	09 99 000 0508	 <table border="1"> <thead> <tr> <th>Contact Part No.</th> <th>Cavity</th> </tr> </thead> <tbody> <tr> <td>09 69 181 x230</td> <td>B</td> </tr> <tr> <td>09 69 281 x230</td> <td>B</td> </tr> <tr> <td>09 69 181 x141</td> <td>C</td> </tr> <tr> <td>09 69 281 x141</td> <td>C</td> </tr> <tr> <td>09 69 181 x140</td> <td>B</td> </tr> <tr> <td>09 69 281 x140</td> <td>B</td> </tr> </tbody> </table>	Contact Part No.	Cavity	09 69 181 x230	B	09 69 281 x230	B	09 69 181 x141	C	09 69 281 x141	C	09 69 181 x140	B	09 69 281 x140	B													
Contact Part No.	Cavity																												
09 69 181 x230	B																												
09 69 281 x230	B																												
09 69 181 x141	C																												
09 69 281 x141	C																												
09 69 181 x140	B																												
09 69 281 x140	B																												
Die (To be ordered separately.)	09 99 000 0515	<table border="1"> <thead> <tr> <th>Contact Part No.</th> <th>Cavity</th> </tr> </thead> <tbody> <tr> <td>09 69 181 x143</td> <td>A</td> </tr> <tr> <td>09 69 281 x143</td> <td>A</td> </tr> </tbody> </table>	Contact Part No.	Cavity	09 69 181 x143	A	09 69 281 x143	A																					
Contact Part No.	Cavity																												
09 69 181 x143	A																												
09 69 281 x143	A																												
Die (To be ordered separately.)	09 99 000 0519	<table border="1"> <thead> <tr> <th>Contact Part No.</th> <th>Cavity</th> </tr> </thead> <tbody> <tr> <td>09 69 181 x233</td> <td>B</td> </tr> <tr> <td>09 69 281 x233</td> <td>B</td> </tr> </tbody> </table>	Contact Part No.	Cavity	09 69 181 x233	B	09 69 281 x233	B																					
Contact Part No.	Cavity																												
09 69 181 x233	B																												
09 69 281 x233	B																												

Tooling crimp

¹⁾ Only the outer ferrule is crimped (inner conductor is soldered)

Tools for crimp termination

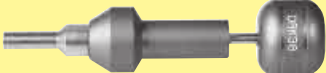
Identification	Part No.										
<p>Hand crimp tool for coaxial contacts, crimp/crimp version¹⁾, suitable for inner contact</p>	09 99 000 0501										
<p>Inner contact die (To be ordered separately.)</p>	09 99 000 0507	 <table border="1" data-bbox="1046 562 1390 913"> <thead> <tr> <th>Contact Part No.</th> </tr> </thead> <tbody> <tr><td>09 69 182 x140</td></tr> <tr><td>09 69 282 x140</td></tr> <tr><td>09 69 182 x230</td></tr> <tr><td>09 69 282 x230</td></tr> <tr><td>09 69 182 x232</td></tr> <tr><td>09 69 282 x232</td></tr> <tr><td>09 69 182 x233</td></tr> <tr><td>09 69 282 x233</td></tr> </tbody> </table>	Contact Part No.	09 69 182 x140	09 69 282 x140	09 69 182 x230	09 69 282 x230	09 69 182 x232	09 69 282 x232	09 69 182 x233	09 69 282 x233
Contact Part No.											
09 69 182 x140											
09 69 282 x140											
09 69 182 x230											
09 69 282 x230											
09 69 182 x232											
09 69 282 x232											
09 69 182 x233											
09 69 282 x233											
<p>Hand crimp tool for coaxial contacts, crimp/crimp version¹⁾, suitable for outer ferrule</p>	09 99 000 0503										
<p>Outer contact die (To be ordered separately.)</p>	09 99 000 0508	 <table border="1" data-bbox="1046 1256 1390 1406"> <thead> <tr> <th>Contact Part No.</th> <th>Cavity</th> </tr> </thead> <tbody> <tr><td>09 69 182 x140</td><td rowspan="2">B</td></tr> <tr><td>09 69 282 x140</td></tr> <tr><td>09 69 182 x230</td><td rowspan="2">B</td></tr> <tr><td>09 69 282 x230</td></tr> </tbody> </table>	Contact Part No.	Cavity	09 69 182 x140	B	09 69 282 x140	09 69 182 x230	B	09 69 282 x230	
Contact Part No.	Cavity										
09 69 182 x140	B										
09 69 282 x140											
09 69 182 x230	B										
09 69 282 x230											
<p>Outer contact die (To be ordered separately.)</p>	09 99 000 0518	<table border="1" data-bbox="1046 1469 1390 1559"> <thead> <tr> <th>Contact Part No.</th> <th>Cavity</th> </tr> </thead> <tbody> <tr><td>09 69 182 x232</td><td rowspan="2">A</td></tr> <tr><td>09 69 282 x232</td></tr> </tbody> </table>	Contact Part No.	Cavity	09 69 182 x232	A	09 69 282 x232				
Contact Part No.	Cavity										
09 69 182 x232	A										
09 69 282 x232											
<p>Outer contact die (To be ordered separately.)</p>	09 99 000 0519	<table border="1" data-bbox="1046 1626 1390 1715"> <thead> <tr> <th>Contact Part No.</th> <th>Cavity</th> </tr> </thead> <tbody> <tr><td>09 69 182 x233</td><td rowspan="2">B</td></tr> <tr><td>09 69 282 x233</td></tr> </tbody> </table>	Contact Part No.	Cavity	09 69 182 x233	B	09 69 282 x233				
Contact Part No.	Cavity										
09 69 182 x233	B										
09 69 282 x233											
<p>Insertion and extraction tool for signal contacts</p>	09 99 000 0511										
<p>Extraction tool for coaxial, power and high voltage contacts</p>	09 99 000 0512										

¹⁾ Both inner and outer conductor are crimped

1. Strip the wire.

2. Attach the sleeve and inner conductor.

3. Crimp the inner conductor.



4. Snap the inner conductor into the contact.

5. Tap the shield on.

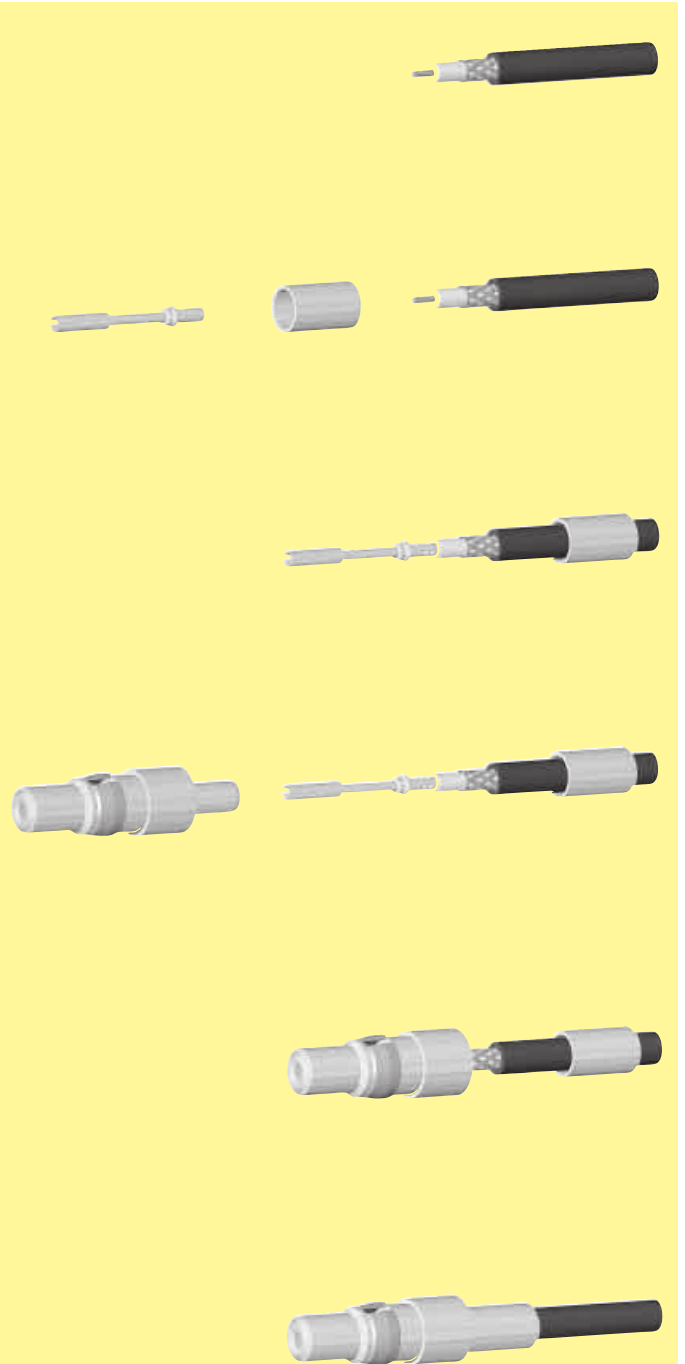
6. Slide the sleeve forwards and crimp.

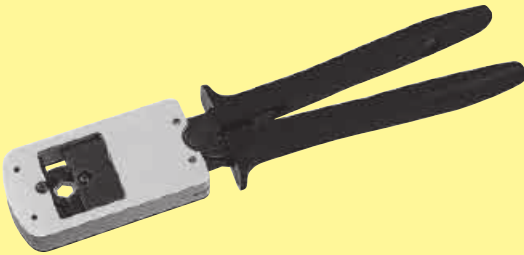

Tools for crimp termination

Identification	Part No.	Drawing																				
Hexagonal head screwdriver for hoods with hexagonal screws	61 03 600 0021																					
Crimp tool for flange and ferrule	61 03 600 0020	 <table border="1" data-bbox="774 790 903 1440"> <thead> <tr> <th>Width of hexagonal nut [mm]</th> </tr> </thead> <tbody> <tr><td>5.0</td></tr> <tr><td>5.5</td></tr> <tr><td>6.0</td></tr> <tr><td>6.5</td></tr> <tr><td>7.0</td></tr> <tr><td>7.5</td></tr> <tr><td>8.0</td></tr> <tr><td>8.5</td></tr> <tr><td>9.0</td></tr> <tr><td>9.5</td></tr> <tr><td>10.0</td></tr> <tr><td>10.5</td></tr> <tr><td>11.0</td></tr> <tr><td>11.5</td></tr> <tr><td>12.0</td></tr> <tr><td>12.5</td></tr> <tr><td>13.0</td></tr> <tr><td>13.5</td></tr> <tr><td>14.0</td></tr> </tbody> </table>	Width of hexagonal nut [mm]	5.0	5.5	6.0	6.5	7.0	7.5	8.0	8.5	9.0	9.5	10.0	10.5	11.0	11.5	12.0	12.5	13.0	13.5	14.0
Width of hexagonal nut [mm]																						
5.0																						
5.5																						
6.0																						
6.5																						
7.0																						
7.5																						
8.0																						
8.5																						
9.0																						
9.5																						
10.0																						
10.5																						
11.0																						
11.5																						
12.0																						
12.5																						
13.0																						
13.5																						
14.0																						
Inserts for crimp tool	61 03 000 0179 61 03 000 0180 61 03 000 0098 61 03 000 0099 61 03 000 0100 61 03 000 0101 61 03 000 0102 61 03 000 0103 61 03 000 0104 61 03 000 0105 61 03 000 0174 61 03 000 0172 61 03 000 0168 61 03 000 0169 61 03 000 0175 61 03 000 0176 61 03 000 0177 61 03 000 0178 61 03 000 0173																					
Mounting tool for flange for D-Sub hoods (9-37 contacts) for D-Sub hoods (50 contacts)	61 03 600 0017 61 03 600 0018																					
Insertion and removal tool for contacts	09 99 000 0171																					

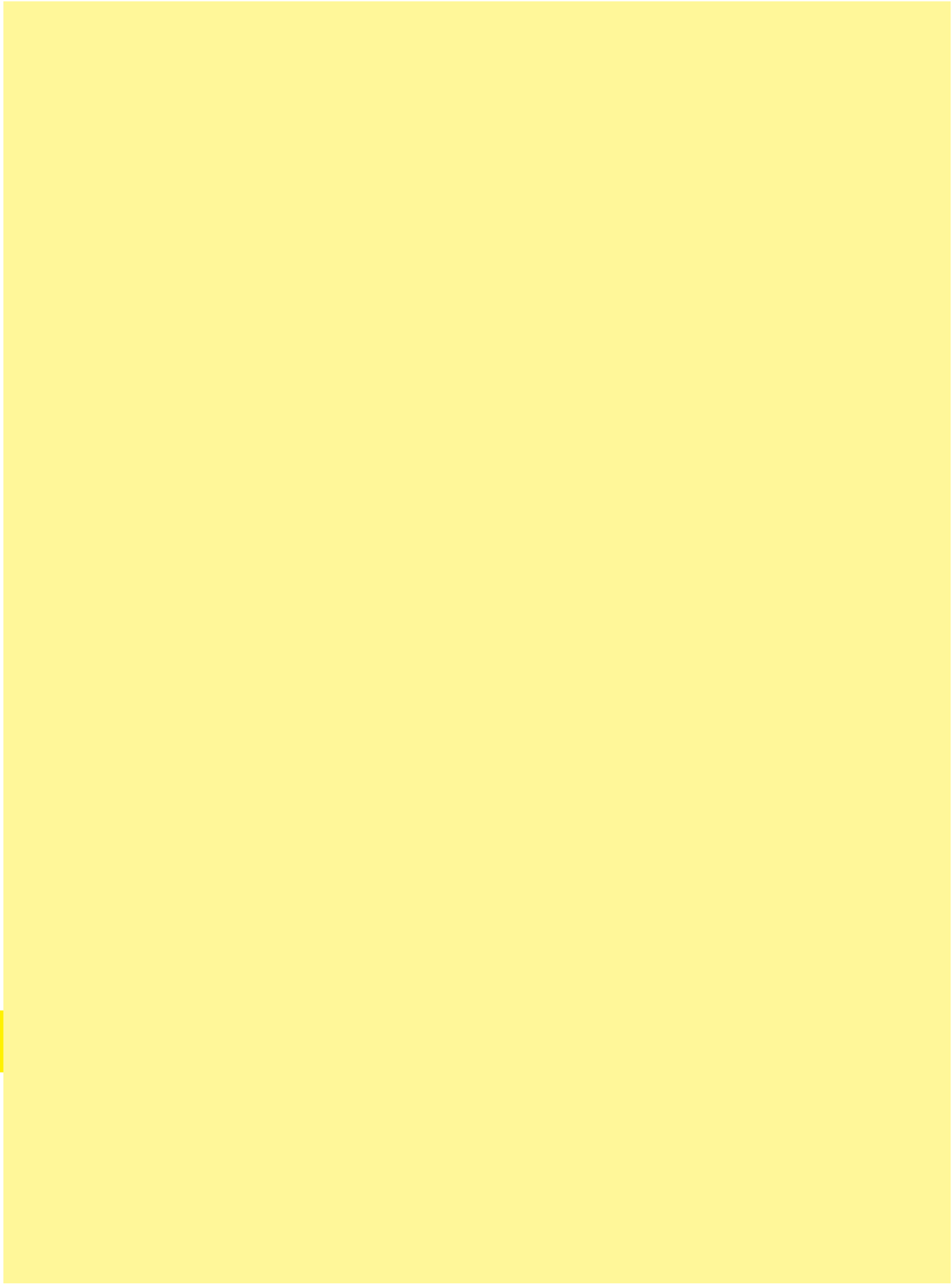

Tooling
crimp